



AMS-7131 Series

Industrial IEEE 802.11 a/b/g/n 2.4GHz/5GHz
Wireless AP/Client/Bridge/Repeater



Version 1.0
(March 2019)

User Manual

www.antaira.com

© Copyright 2019 Antaira Technologies, LLC.
All Rights Reserved

This document contains information which is protected by copyright. Reproduction, adaptation, or translation without prior permission is prohibited, except as allowed under the copyright laws.

Trademark Information

Antaira is a registered trademark of Antaira Technologies, LLC., Microsoft Windows and the Windows logo are the trademarks of Microsoft Corp. All other brand and product names are trademarks or registered trademarks of their respective owners.

Disclaimer

Antaira Technologies, LLC. provides this manual without warranty of any kind, expressed or implied, including but not limited to the implied warranties of merchantability and fitness for a particular purpose. Antaira Technologies, LLC. may make improvements and/or changes to the product and/or specifications of the product described in this manual, without prior notice. Antaira Technologies, LLC. will not be liable for any technical inaccuracies or typographical errors found in this guide. Changes are periodically made to the information contained herein and will be incorporated into later versions of the manual. The information contained is subject to change without prior notice.

FCC Notice

This equipment has been tested and found to comply with the limits for a Class-A digital device, pursuant to Part 15 of the FCC rules. These limits are designed to provide reasonable protection against harmful interference in a residential installation. This equipment generates, uses, and can radiate radio frequency energy. It may cause harmful interference to radio communications if the equipment is not installed and used in accordance with the instructions. However, there is no guarantee that interference will not occur in a particular installation. If this equipment does cause harmful interference to radio or television reception, which can be determined by turning the equipment off and on, the user is encouraged to try to correct the interference by one or more of the following measures:

- Reorient or relocate the receiving antenna.
- Increase the separation between the equipment and receiver.
- Connect the equipment into an outlet on a circuit different from that to which the receiver is connected.
- Consult the dealer or an experienced radio/TV technician for help.

Caution: Any changes or modifications not expressly approved by the grantee of this device could void the user's authority to operate the equipment.

CE Mark Warning

This is a Class-A product. In a domestic environment this product may cause radio interference in which case the user may be required to take adequate measures.

Industrial Ethernet Wireless APs

Hardware User Manual

This manual supports the following models:

- AMS-7131
- AMS-7131-T

Please check our website (www.antaira.com) for any updated manual or contact us by e-mail (support@antaira.com).

Table of Contents

1. Overview	1
1.1 Key Features.....	1
1.2 Package Contents.....	1
1.3 Safety Precaution.....	2
2. Hardware Description	3
2.1 Physical Dimensions	3
2.2 Front Panel.....	4
2.3 LED Indicators	5
2.4 Ethernet Ports.....	6
2.5 Wireless Antenna	6
2.6 Cabling.....	7
2.7 Wiring the Power Inputs	7
2.8 Grounding Note	8
3. Mounting Installation	8
3.1 DIN-Rail Mounting.....	8
3.2 Wall Mounting.....	10
4. Hardware Installation.....	12
4.1 Installation Steps.....	12
4.2 Maintenance and Service	12

1. Overview

Antaira Technologies' AMS-7131 series is designed for industrial and enterprise wireless access applications. With the Qualcomm/Atheros AR9582 SoC chipset installed, it boasts network robustness, stability, and a wide network coverage. Based on IEEE 802.11a/b/g/n, the access point supports high-speed data transmission of up to 300Mbps.

The AMS-7131 series is capable of operating in different modes which makes it suitable for a wide variety of wireless applications including long-distance deployments. The unit also allows the user to position the wireless antenna in a better signal-broadcasting location for improved wireless coverage and signal strength or simply in a more convenient location.

1.1 Key Features

- System Interface/Performance
 - Qualcomm/Atheros AR9582 SoC
 - 2* 10/100BaseT(X) RJ45 Ethernet Ports
 - WLAN supports 2.4GHz/5GHz Wi-Fi
 - Two Industrial External SMA Antenna 3dBi for 2.4GHz
- Power Input
 - DC 9~48V a 6-pin removal terminal block
- Operating Temperature
 - Standard operating temperature model: 0°C ~ 60°C
 - Extended operating temperature model (-T): -35°C ~ 70°C
- Case/Installation
 - IP-30 protection
 - DIN-Rail and wall mount design

1.2 Package Contents

- 1 - Quick Installation Guide
- 1 – AMS-7131 Series
- 1 - Wall Mounting Bracket Set with Screws
- 1 – Terminal Block
- 2 – Antennas

1.3 Safety Precaution

Attention

If the DC voltage is supplied by an external circuit, please use a protection device on the power supply input. Supply by UL Listed industrial use power. The industrial wireless AP's (access point) hardware specs, ports, cabling information, and wiring installation will be described within this user manual.

Warning Labels

The caution label means that you should check the certain information on user manual when working with the device. (Shown in *Figure 1*)

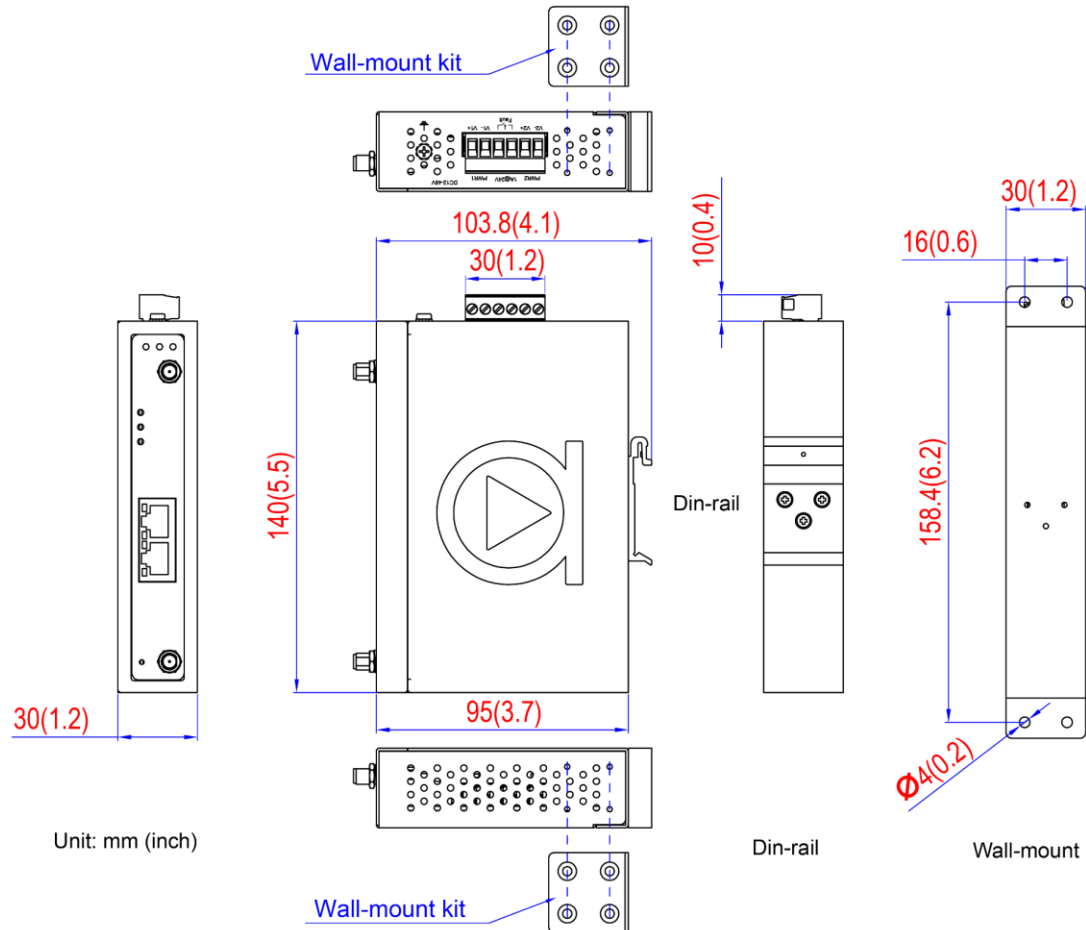

Figure 1: Caution Label

2. Hardware Description

2.1 Physical Dimensions

Figure 2.1, below, shows the physical dimensions of AMS-7131 series.



(W x H x D) is 30mm x 140mm x 95mm

Figure 2.1

Physical Dimensions

2.2 Front Panel

The front panel of the AMS-7131 series can be seen below (*Figure 2.2*).

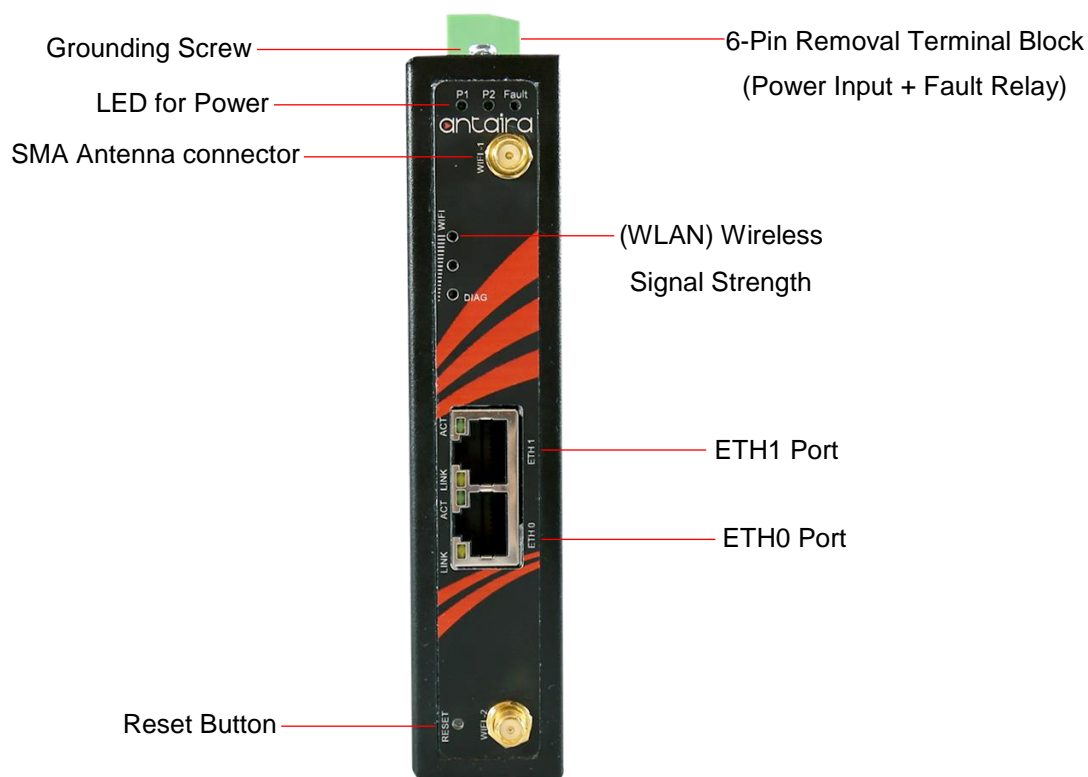

Figure 2.2
Front Panel

2.3 LED Indicators

There are LED light indicators located on the front panel of the industrial wireless AP that displays the network, power, and wireless status. Each LED indicator has its own specific meaning, see below in *Table 2.3*.

LED	Color	Description	
P1 / P2	Green	On	Power input is active
		Off	Power input is inactive
Fault	Red	On	Fault has been detected
		Off	No Fault
WLAN Signal Strength	Green/Red	Red	Less than 25% signal strength
		Green	LED 2 Less than 50% signal strength
		Green	LED 3 Less than 75% signal strength
		Green	LED 4 Less than 100% signal strength
ETH Ports 1 & 2 (ACT)		Green	Connected to network, 10/100Mbps
		Flashing	Networking is active
		Off	Not connected to network
ETH Ports 1 & 2 (LINK)		Amber	Link established
		Off	No Link detected

Table 2.3
LED Indicators

2.4 Ethernet Ports

■ RJ-45 Ports

RJ-45 Ports (Auto MDI/MDIX): The RJ-45 port is auto-sensing for 10Base-Tx or 100Base-Tx device connections. Auto MDI/MDIX means that the wireless AP can connect to another switch or workstation without changing the straight-through or crossover cabling. See the figures shown below for the straight-through and crossover cabling schematics.

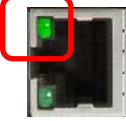
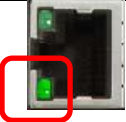
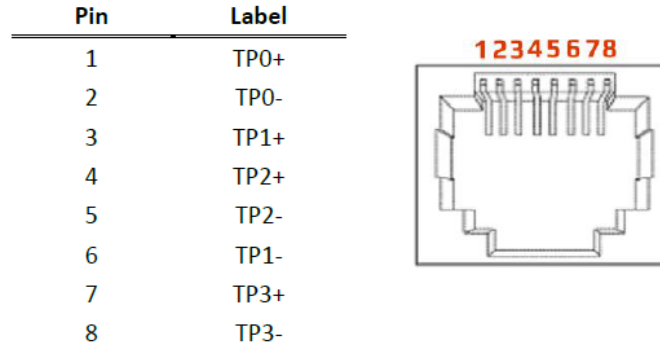

Figure 2.3: RJ-45 Ethernet Port Pin

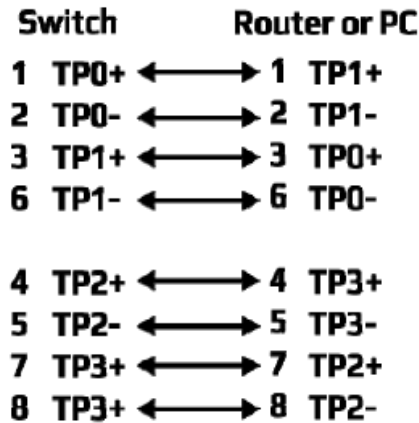

Figure 2.4
 Straight-Through Cables Schematic

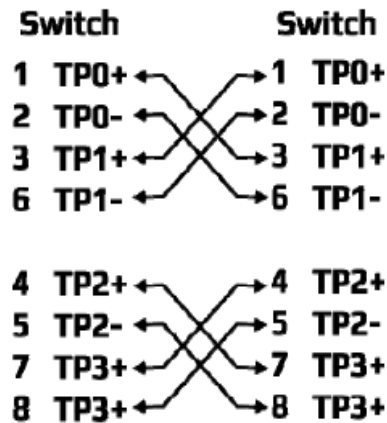

Figure 2.5
 Crossover Cables Schematic

2.5 Wireless Antenna

2.4/5 GHz antennas are used with the AMS-7131. They are connected with reversed SMA connectors. External antennas can also be applied.

2.6 Cabling

- Twisted-pair segments can be connected with an Unshielded Twisted Pair (UTP) or Shielded Twisted Pair (STP) cable. The cable between the equipment and the link partner (wireless AP, switch, hub, workstation, etc.) must be less than 100 meters (328 ft.) long.

2.7 Wiring the Power Inputs

Please follow the steps below to insert the power wire.

1. Insert the positive and negative wires into the V+, V- contacts on the terminal block connector as shown below in *Figure 2.7*.

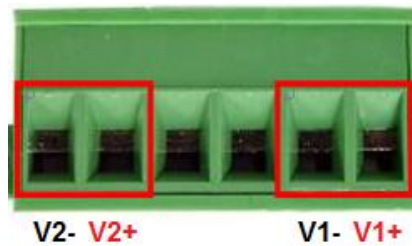

Figure 2.7

Power Terminal Block

2. Tighten the wire-clamp screws to prevent the wires from loosening, as shown below in *Figure 2.8*.



Figure 2.8

Power Terminal Block

2.8 Grounding Note

Grounding and wire routing help limit the effects of noise due to electromagnetic interference (EMI). Run the ground connection from the ground screw to the grounding surface prior to connecting devices. The grounding screw symbol is shown below in *Figure 2.9*.



Figure 2.9
Grounding screw



Caution: Using a shielded cable achieves better electromagnetic compatibility.

3. Mounting Installation

3.1 DIN-Rail Mounting

The DIN-Rail is pre-installed on the industrial wireless AP from the factory. If the DIN-Rail is not on the product, please refer to *Figure 3.1* to learn how to install the DIN-Rail on the product.

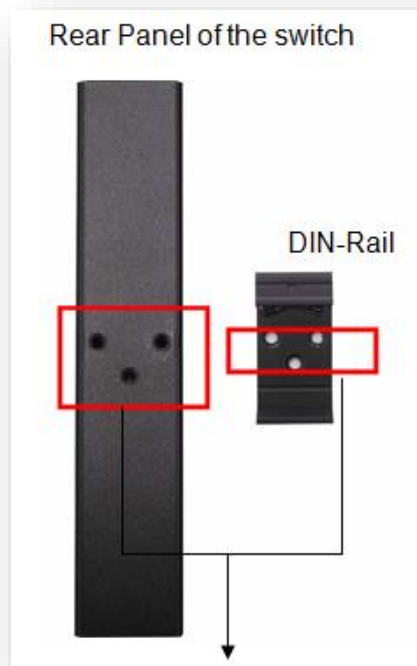

Figure 3.1

The Rear Side of the wireless AP and DIN-Rail Bracket

Follow the steps below to learn how to hang the industrial wireless AP.

1. Use the screws to install the DIN-Rail bracket on the rear side of the industrial wireless AP.



Caution: The torque for tightening the screws on the device is 3.5 in-lbs.

2. To remove the DIN-Rail bracket, do the opposite from Step 1.
3. After the DIN-Rail bracket is installed on the rear side of the wireless AP, insert the top of the DIN-Rail on to the track as shown below in *Figure 3.2*.



Figure 3.2

Insert on the DIN-Rail

4. Lightly pull down the bracket onto the rail as shown below in *Figure 3.3*.

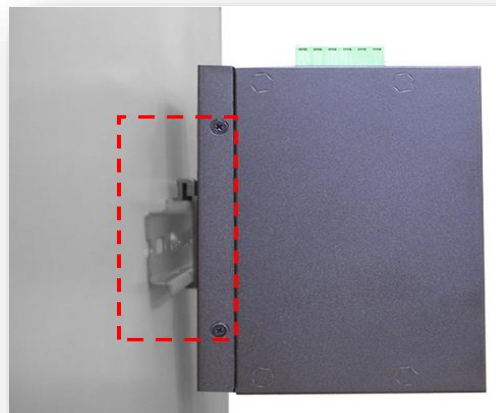

Figure 3.3

Secure on to the DIN-Rail

5. Check if the bracket is mounted tightly on the rail.
6. To remove the industrial wireless AP from the rail, do the opposite from the above steps.

3.2 Wall Mounting

Follow the steps below to mount the industrial wireless AP using the wall mounting bracket as shown below in *Figure 3.4*.



Caution: “Wall” means industrial control panel wall.

1. Remove the DIN-Rail bracket from the industrial wireless AP by loosening the screws.
2. Place the wall mounting brackets on the top and bottom of the industrial wireless AP.
3. Use the screws to screw the wall mounting bracket on the industrial wireless AP.



Caution: The torque for tightening the screws on the device is 3.5 in-lbs.

4. Use the hook holes at the corners of the wall mounting bracket to hang the industrial wireless AP on the wall.
5. To remove the wall mount bracket, do the opposite from the steps above.



Figure 3.4

Remove DIN-Rail Bracket

Below, in *Figure 3.5*, are the dimensions of the wall mounting bracket.

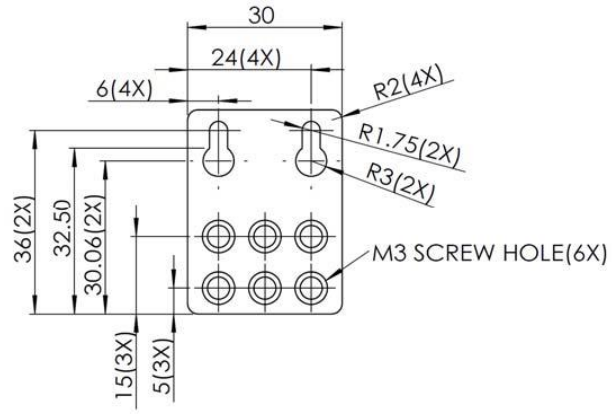

Figure 3.5
Wall Mounting Bracket Dimensions

4. Hardware Installation

4.1 Installation Steps

This section will explain how to install Antaira Technologies' AMS-7131 series.

Caution:



1. This device is intended for indoor use and at altitudes up to 2000 meters.
2. This device is intended to be installed in an industrial control enclosure and panel.

Installation Steps

1. Unpack the industrial wireless AP from the original packing box.
2. Check if the DIN-Rail bracket is screwed on the industrial wireless AP.
 - a. If the DIN-Rail is not screwed on the industrial wireless AP, please refer to the **DIN-Rail Mounting** section for DIN-Rail installation.
 - b. For wall mounting, please refer to the **Wall Mounting** section for wall mounting installation.
3. For DIN-Rail or wall mounting, please refer to the **Mounting Installation** section.
4. Power on the industrial wireless AP, then the power LED light will turn on.
 - a. For wiring power, please refer to the **Wiring the Power Inputs** section.
 - b. Please refer to the **LED Indicators** section for LED light indication.
5. Prepare the twisted-pair, straight-through category 5 cable for Ethernet connection.
6. Insert one side of the RJ-45 cable into the wireless AP's Ethernet port and on the other side into the networking device's Ethernet port, e.g. switch, PC, or server. The Ethernet port's (RJ-45) LED on the industrial wireless AP will turn on when the cable is connected to the networking device.
 - a. Please refer to the **LED Indicators** section for LED light indication information.
7. When all connections are set and the LED lights all show normal, the installation process is complete.

4.2 Maintenance and Service

- If the device requires servicing of any kind, the user is required to disconnect and remove it from its mounting. The initial installation should be done in a way that makes this as convenient as possible.
- Voltage/Power lines should be properly insulated as well as other cables. Be careful when handling them so as to not trip over.

- Do not under any circumstance insert foreign objects of any kind into the heat dissipation holes located in the different faces of the device. This may not only harm the internal layout, but might cause harm to the user as well.
- Do not under any circumstance open the device for any reason. Please contact your dealer for any repair needed or follow the instructions within the manual.
- Clean the device with dry soft cloth

Antaira Customer Service and Support

(Antaira US Headquarter) + 844-268-2472

(Antaira Europe Office) + 48-22-862-88-81

(Antaira Asia Office) + 886-2-2218-9733

Please report any problems to Antaira:

www.antaira.com / support@antaira.com

www.antaira.eu / info@antaira.eu

www.antaira.com.tw / info@antaira.com.tw

Any changes to this material will be announced