



IMP-C1000-SFP-bt-24 Series

Compact Industrial Gigabit IEEE 802.3bt Ethernet-to-Fiber Media Converter, 1*10/100/1000Tx (90W/Port) to 1*100/1000 SFP Slot; 12~55VDC Power Input



Version 1.0

User Manual



www.antaira.com

© Copyright 2020 Antaira Technologies, LLC.

All Rights Reserved

This document contains information, which is protected by copyright. Reproduction, adaptation or translation without prior permission is prohibited, except as allowed under the copyright laws.

Trademark Information

Antaira is a registered trademark of Antaira Technologies, LLC., Microsoft Windows and the Windows logo are the trademarks of Microsoft Corp. All other brand and product names are trademarks or registered trademarks of their respective owners.

Disclaimer

Antaira Technologies, LLC. provides this manual without warranty of any kind, expressed or implied, including but not limited to the implied warranties of merchantability and fitness for a particular purpose. Antaira Technologies, LLC. may make improvements and/or changes to the product and/or specifications of the product described in this manual, without prior notice. Antaira Technologies, LLC. will not be liable for any technical inaccuracies or typographical errors found in this guide. Changes are periodically made to the information contained herein and will be incorporated into later versions of the manual. The information contained is subject to change without prior notice.

FCC Notice

This equipment has been tested and found to comply with the limits for a Class-A digital device, pursuant to Part 15 of the FCC rules. These limits are designed to provide reasonable protection against harmful interference in a residential installation. This equipment generates, uses, and can radiate radio frequency energy. It may cause harmful interference to radio communications if the equipment is not installed and used in accordance with the instructions. However, there is no guarantee that interference will not occur in a particular installation. If this equipment does cause harmful interference to radio or television reception, which can be determined by turning the equipment off and on, the user is encouraged to try to correct the interference by one or more of the following measures:

- Reorient or relocate the receiving antenna.
- Increase the separation between the equipment and receiver.
- Connect the equipment into an outlet on a circuit different from that to which the receiver is connected.
- Consult the dealer or an experienced radio/TV technician for help.

Caution: Any changes or modifications not expressly approved by the grantee of this device could void the user's authority to operate the equipment.

CE Mark Warning

This is a Class-A product. In a domestic environment, this product may cause radio interference in which case the user may be required to take adequate measures.

Industrial Ethernet Media Converters

User Manual (May 2020)

This manual supports the following models:

- IMP-C1000-SFP-bt-24
- IMP-C1000-SFP-bt-24-T

Please check our website (www.antaira.com) for any updated manual or contact us by e-mail (support@antaira.com).

Table of Contents

1.	Overview	1
1.1	Key Features	1
1.2	Package Contents	2
1.3	Safety Precaution	2
2.	Hardware Description	3
2.1	Physical Dimensions	3
2.2	Front Panel.....	4
2.3	Top View	4
2.4	LED Indicators.....	5
2.5	DIP-Switch Setting.....	5
2.6	Ethernet Ports	6
2.7	Cabling	6
2.8	Wiring the Power Inputs.....	9
3.	Mounting Installation	10
3.1	DIN-Rail Mounting	10
3.2	Wall Mounting.....	12
4.	Hardware Installation	13
4.1	Installation Steps	13
5.	Trouble Shooting	14
6.	Technical Specifications	15

1. Overview

Antaira Technologies' **IMP-C1000-SFP-bt-24** series is a compact IP30 rated gigabit Ethernet-to-fiber media converter featuring a 10/100/1000TX Ethernet port that supports IEEE 802.3bt high power PoE that can supply up to 90 watts, and a dual rate 100/1000 SFP slot. It is perfectly designed to fulfill industrial applications that require distance extension and high bandwidth capabilities. This small form factor is ideal for saving space in outdoor applications such as factory automation, security, ITS transportation, power/utility, water wastewater treatment plants, and any other extreme ambient weather environments.

The IMP-C1000-SFP-bt-24 series has a built-in "Link Fault Pass Through" (LFP) and "PD Remote Reset Technology" (PRRT) function with 12~55VDC redundant power inputs with reverse polarity and overload current protection. This product series supports DIN-rail as well as wall mountable orientations. There are two operating temperature range models in STD: -10°C to 65°C and EOT: -40°C to 75°C.

1.1 Key Features

- System Interface/Performance
 - RJ-45 ports support the auto MDI/MDI-X function
 - Embedded 1*10/100/1000Tx (PSE 90W) and 1*100/1000 SFP Slot
 - Store-and-forward switching architecture
 - 8K MAC address table size
 - Supports 10Kbytes jumbo frame
 - 1Mbit memory buffer
- Power Input
 - DC 12~55V redundant power with a 4-pin removal terminal block
 - Max. current: 7A
 - Max. PoE output: 90W
- Certification
 - FCC, CE
- Operating Temperature
 - Standard operating temperature model: -10°C ~ 65°C
 - Extended operating temperature model (-T): -40°C ~ 75°C
- Case/Installation
 - IP-30 protection
 - DIN-Rail and wall mount design

1.2 Package Contents

- 1 - Quick Installation Guide
- 1 - IMP-C1000-SFP-bt-24(-T)
- 1 - Wall mounting bracket set with screws
- 1 - DC cable - 18 AWG & DC jack 5.5x2.1mm

1.3 Safety Precaution

Attention: If the DC voltage is supplied by an external circuit, please use a protection device on the power supply input. The industrial Ethernet media converter's hardware specs, ports, cabling information, and wiring installation will be described within this user manual.

2. Hardware Description

2.1 Physical Dimensions

Figure 2.1, below, shows the physical dimensions of Antaira Technologies' IMP-C1000-SFP-bt-24 series.

(W x D x H) is 30mm x 95mm x 75mm

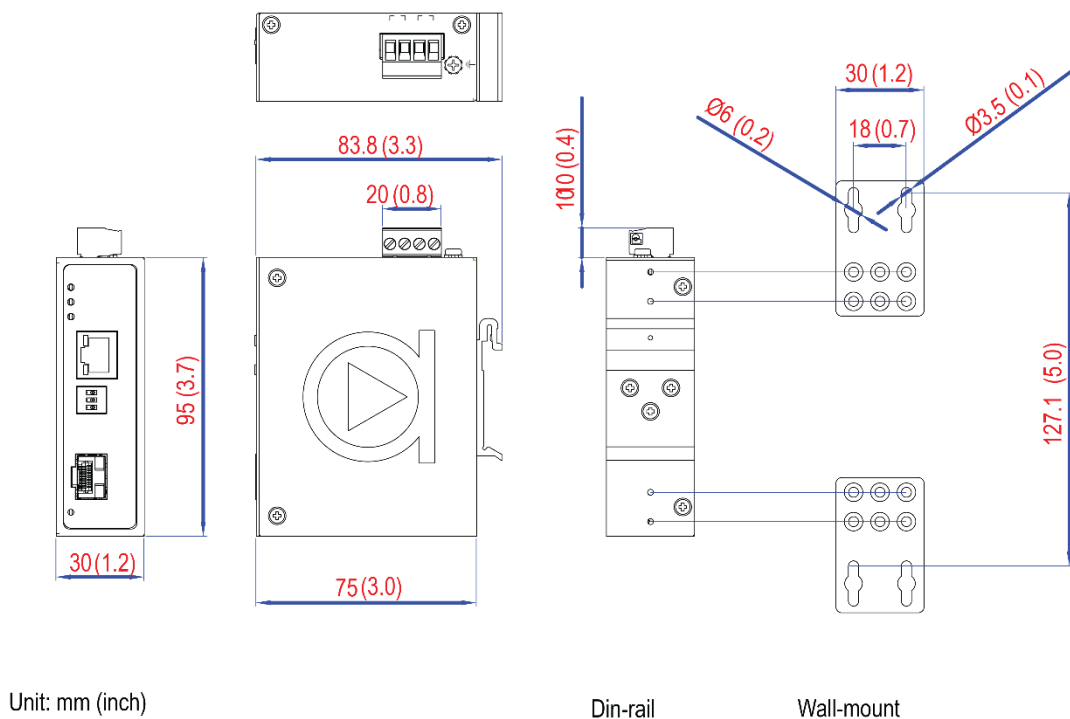

Figure 2.1
Physical Dimensions

2.2 Front Panel

The front panel of the IMP-C1000-SFP-bt-24 series can be seen below (Figure 2.2).

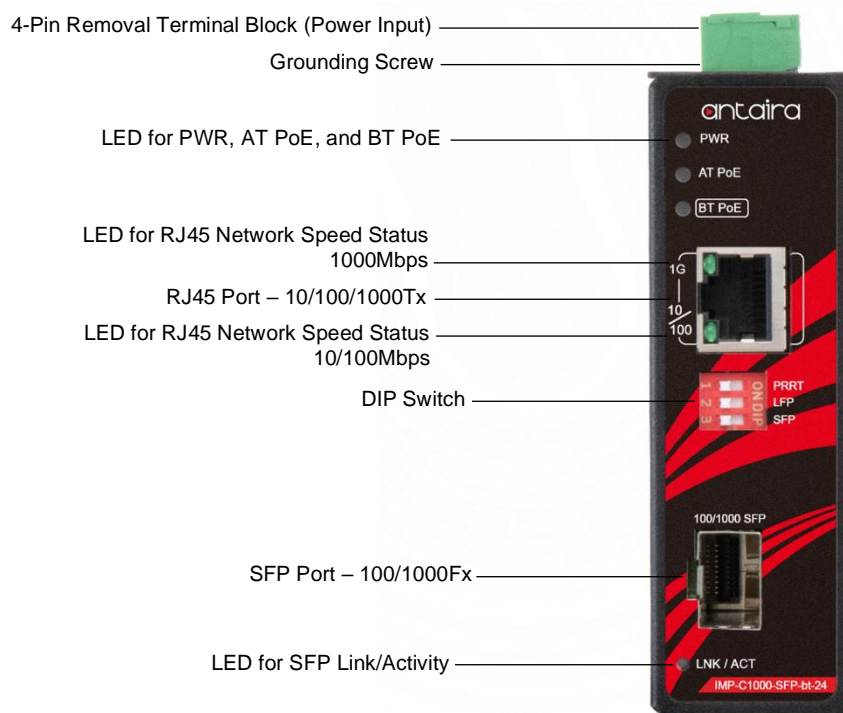

Figure 2.2
 Front Panel

2.3 Top View

Figure 2.3, below, shows the top panel of the IMP-C1000-SFP-bt-24 series media converter that is equipped with one 4-pin removal terminal block connector for dual DC power inputs (12~55VDC).

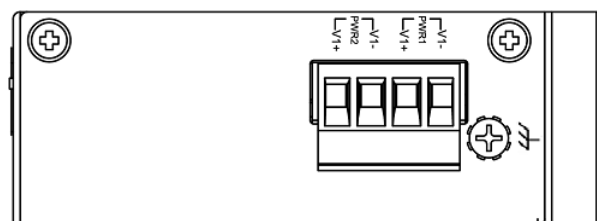

Figure 2.3
 Top Panel View

2.4 LED Indicators

There are LED light indicators located on the front panel of the industrial Ethernet media converter that displays the power and network status. Each LED indicator has a different color and has its own specific meaning, see below in *Table 2.1*.



LED	Color	Description	
Power	Green	On	Power input 1 or 2 is active
		Off	Power input 1 and 2 are inactive
AT PoE	Green	On	IEEE 802.3af/at connection
		Off	No powered-device attached or power supplying fails
BT PoE	Blue	On	IEEE 802.3bt connection
		Flashing (1 time/s)	1. PoE over current or cable short 2. Invalid connection check signature or connection-check error is detected
		Off	No powered-device attached or power supplying fails
RJ45 Port (Upper LED)	 Green	On	Linked to network at 1000Mbps
		Flashing	Networking is active
		Off	Not connected to network
RJ45 Port (Lower LED)	 Green	On	Linked to network at 10/100Mbps
		Flashing	Networking is active
		Off	Not connected to network
SFP Port Link/Act	Green	On	Connected to network, 100/1000Mbps
		Flashing	Networking is active
		Off	Not connected to network

Table 2.1
LED Indicators

2.5 DIP-Switch Setting

There are 3-sets of DIP-switches on the front panel that are responsible for the settings of PRRT (PD Remote Reset Technology) function, LFP (Link Fault Pass) function, and SFP transmission rate (see below in *Table 2.2*).

DIP-Switch Number	ON	OFF
1	PRRT Enabled	PRRT Disabled
2	LFP Enabled	LFP Disabled
3	SFP 100Fx	SFP 1000Fx

Table 2.2

Note: After any DIP switch changes have been made, it is required to power cycle the unit for the changes to take effect.

2.6 Ethernet Ports

■ RJ-45 Ports

RJ-45 Ports (Auto MDI/MDIX): The RJ-45 port is auto-sensing for 10/100Base-Tx or 1000Base-Tx device connections. Auto MDI/MDIX means that the media converter can connect to another switch or workstation without changing the straight-through or crossover cabling. See the figures shown below for the straight-through and crossover cabling schematics.

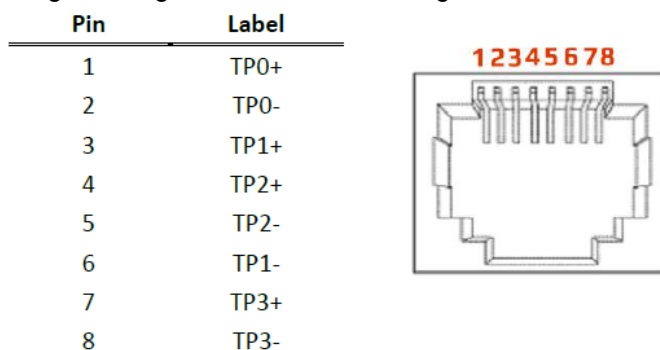

Figure 2.4: RJ-45 Ethernet Port Pin

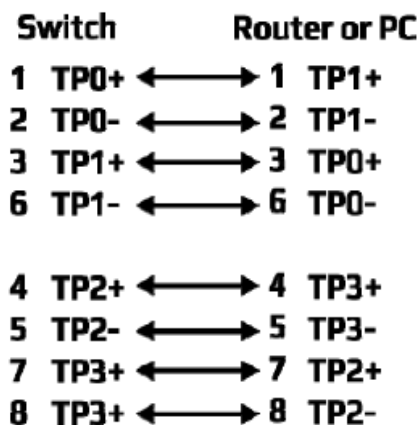

Figure 2.5
Straight-Through Cables Schematic

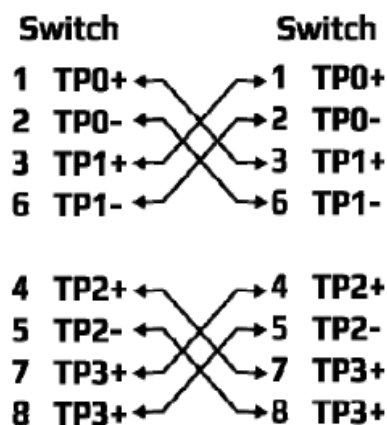

Figure 2.6
Crossover Cables Schematic

2.7 Cabling

- Twisted-pair segments can be connected with an Unshielded Twisted Pair (UTP) or Shielded Twisted Pair (STP) cable. The cable between the equipment and the link partner (media converter, switch, hub, workstation, etc.) must be less than 100 meters (328 ft.) long.
- The Small Form Factor pluggable (SFP) is a compact optical transceiver used in optical communications for both telecommunication and data communication applications.

- To connect the transceiver and LC cable, please follow the steps below:
 - **Step 1** - Insert the SFP transceiver module into the SFP slot as shown below in *Figure 2.7*. Notice that the triangle mark is at the bottom of the SFP slot. *Figure 2.8* shows the SFP transceiver module was inserted.



Figure 2.7 - Transceiver to the SFP Slot

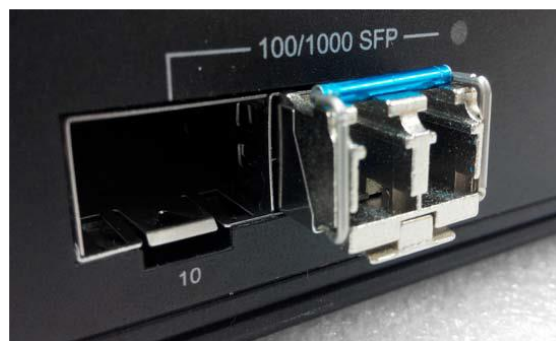

Figure 2.8 - Transceiver Inserted

- **Step 2** - Insert the fiber cable of the LC connector into the transceiver as shown below in *Figure 2.9*.

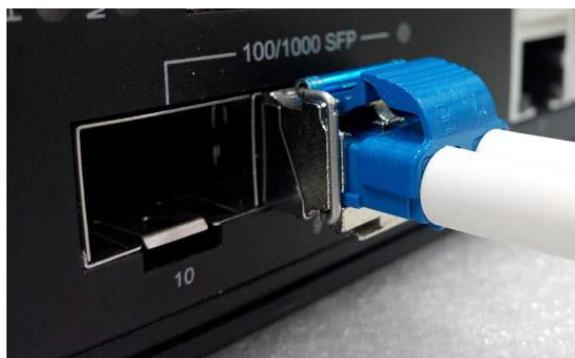

Figure 2.9 - LC Connector to the Transceiver

- To remove the LC connector from the transceiver, please follow the steps shown below:
 - **Step 1** - Press the upper side of the LC connector from the transceiver and pull it out to release as shown below in *Figure 2.10*.
 - **Step 2** - Push down the metal clasp and pull the transceiver out by the plastic part as shown below in *Figure 2.11*.

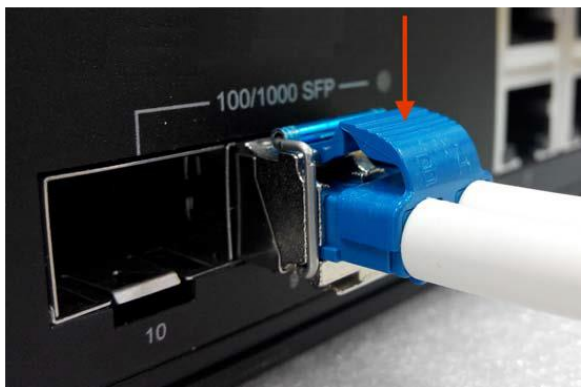

Figure 2.10 – Remove LC Connector

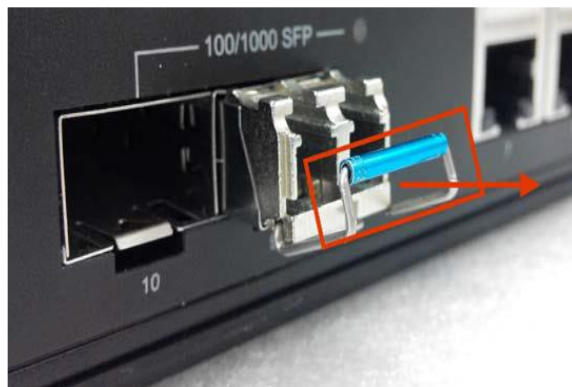

Figure 2.11 – Pull Out from SFP Slot

2.8 Wiring the Power Inputs

Please follow the steps below to insert the power wire.

1. Insert the positive and negative wires into the PWR1 (V1+, V1-) and PWR2 (V2+, V2-) contacts on the terminal block connector as shown below in *Figure 2.12*.

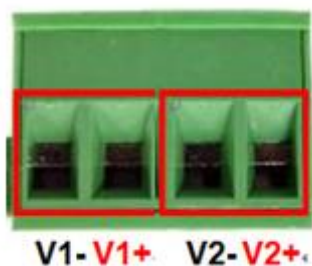

Figure 2.12
Power Terminal Block

2. Tighten the wire-clamp screws to prevent the wires from loosening, as shown below in *Figure 2.13*.

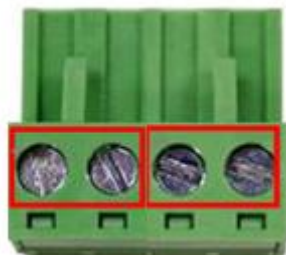

Figure 2.13
Power Terminal Block

-
- **Note:**
- Only use copper conductors, **125° C**, tighten to **5 lbs.**
 - The wire gauge for the terminal block should range between **18~20 AWG**.
-

3. Mounting Installation

3.1 DIN-Rail Mounting

The DIN-Rail is pre-installed on the industrial Ethernet media converter from the factory. If the DIN-Rail is not on the industrial Ethernet media converter, please refer to *Figure 3.1* to learn how to install the DIN-Rail on the media converter.

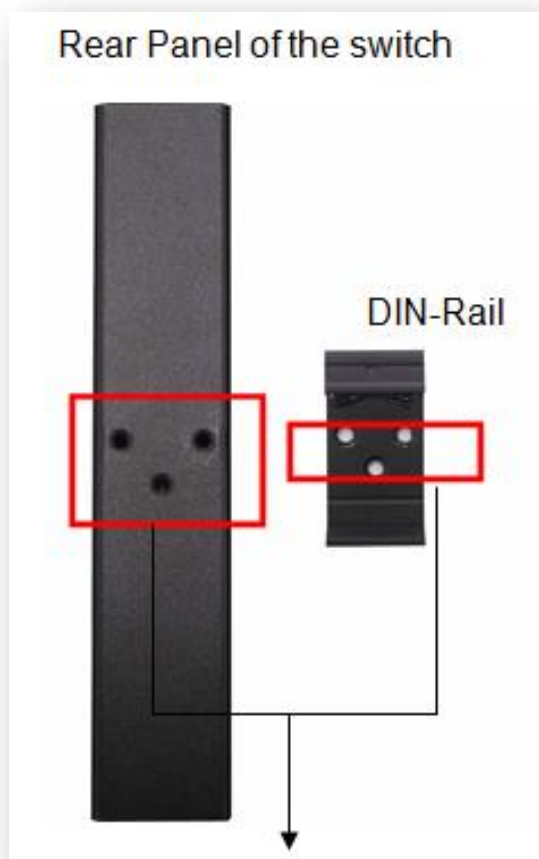

Figure 3.1

The Rear Side of the Media Converter and DIN-Rail Bracket

Follow the steps below to learn how to hang the industrial Ethernet media converter.

1. Use the screws to install the DIN-Rail bracket on the rear side of the industrial Ethernet media converter.
2. To remove the DIN-Rail bracket, do the opposite from step 1.
3. After the DIN-Rail bracket is installed on the rear side of the media converter, insert the top of the DIN-Rail onto the track as shown below in *Figure 3.2*.



Figure 3.2
Insert on the DIN-Rail

4. Lightly pull down the bracket onto the rail as shown below in *Figure 3.3*.

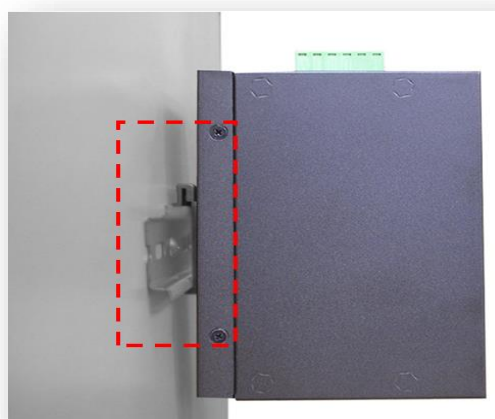

Figure 3.3
Secure on to the DIN-Rail

5. Check if the bracket is mounted tightly on the rail.
6. To remove the industrial Ethernet media converter from the rail, do the opposite from the above steps.

4. Hardware Installation

4.1 Installation Steps

This section will explain how to install Antaira Technologies' IMP-C1000-SFP-bt-24(-T) series.

Installation Steps

1. Unpack the industrial media converter from the original packing box.
2. Check if the DIN-Rail bracket is screwed on the industrial media converter.
 - a. If the DIN-Rail is not screwed on the industrial media converter, please refer to the **DIN-Rail Mounting** section for DIN-Rail installation.
 - b. For wall mounting, please refer to the **Wall Mounting** section for wall mounting installation.
3. For DIN-Rail or wall mounting, please refer to the **Mounting Installation** section.
4. Power on the industrial media converter; the power LED light will turn on.
 - a. For wiring power, please refer to the **Wiring the Power Inputs** section.
 - b. Please refer to the **LED Indicators** section for LED light indication.
5. Prepare the twisted-pair, straight-through category 5 cable for Ethernet connection.
6. Insert one side of the RJ-45 cable into the media converter's Ethernet port and on the other side into the networking device's Ethernet port, e.g. switch PC or server. The Ethernet port's (RJ-45) LED on the industrial media converter will turn on when the cable is connected to the networking device.
 - a. Please refer to the **LED Indicators** section for LED light indication information.
7. Insert one side of the SFP cable into the media converter's SFP port and on the other side into the networking device's SFP port, e.g. switch or server. The SFP port's LED on the industrial media converter will turn on when the cable is connected to the networking device.
 - a. Please refer to the **LED Indicators** section for LED light indication information.
8. When all connections are set and the LED lights all show normal, the installation process is complete.

5. Trouble Shooting

- Always verify the right power cord or adapter is being used. Never use a power supply or adapter with a non-compliant DC output voltage or it will burn the equipment.
- Select the proper UTP or STP cable in order to construct the network. Use an Unshielded Twisted-Pair (UTP) or Shield Twisted-Pair (STP) cable for RJ-45 connections: 100Ω Category 5e for 10/100/1000Mbps. Also be sure that the length of any twisted-pair connection does not exceed 100 meters (328 feet).
- **Diagnosing LED Indicators:** To assist in identifying problems, the media converter can be easily monitored with the LED indicators which help to identify if any problems exist.
 - Please refer to the LED Indicators section for LED light indication information.
- If the power indicator LED does not turn on when the power cord is plugged in, the user may have a problem with the power cord. Check for loose power connections, power losses or surges at the power outlet.
 - Please contact Antaira for technical support if the problem cannot be resolved.
- If the industrial media converter LED indicators are normal and the connected cables are correct but the packets still cannot transmit, please check the system's Ethernet devices' configuration or status.

6. Technical Specifications

Table 6.1 has the technical specifications for Antaira Technologies' IMP-C1000-SFP-bt-24 series.

Standards	IEEE 802.3	10BaseT Ethernet
	IEEE 802.3u	100BaseTX Fast Ethernet
	IEEE 802.3ab	1000BaseT Gigabit Ethernet
	IEEE 802.3z	1000Base-X Gigabit Fiber
	IEEE 802.3af/at/bt	Power over Ethernet
Technology	Data Process	Store and Forward
	Protocol	CSMA/CD
	Flow Control	IEEE 802.3x flow control, back pressure control
	Memory Buffer	1Mbit
	Jumbo Frame	10Kbytes
	MAC Table Size	8K
Port Interface	Ethernet (RJ45) Port	1*10/100/1000Tx with IEEE 802.3bt PoE Auto-Negotiation, Full/Half Duplex, Auto-MDI/MDI-X
	PoE Pin Out	V-, V-, V+, V+, for pin 1, 2, 3, 6; V+, V+, V-, V-, for pin 4, 5, 7, 8 *Support Modes: Mode A, Mode B, 4-Pair Mode
	Fiber Port	1*100/1000Fx SFP Slot
	Fiber Wavelength	Refer to SFP Module
	DIP Switch	DIP Switch 1: PD Remote Reset Technology (PRRT) Enable/Disable DIP Switch 2: Link Fault Pass-Through (LFP) Enable/Disable DIP Switch 3: 100Mbps/1000Mbps
	LED Indicators	Power Status LED, IEEE 802.3af/at PoE Enabled LED, IEEE 802.3bt Enabled LED Ethernet Ports: On-Link/Flash-data transmitting SFP: Link/Active
Mechanical Characteristics	Housing	Metal IP30 protection
	Dimension	30 x 95 x 75 mm
	Weight	Unit Weight: 0.74 lb. Shipping Weight: 0.94 lb.
	Mounting	DIN-Rail Mounting, Wall Mounting
Power Requirement	Input Voltage	12~55VDC Redundant Input
	Power Connection	1 removable 4-contact terminal block
	Power Consumption	3W
	Max. PoE Power Budget	90W
Environmental Limits	Operating Temperature	Standard: -10°C to 65°C EOT: -40°C to 75°C
	Ambient Relative Humidity	5% to 95%, (non-condensing)
	Storage Temperature	-40°C to 85°C
Regulatory Approvals	EMI	FCC Part 15 Subpart B Class A, CE EN55032/EN61000-6-4 Class A
	EMS	CE EN55035/EN61000-6-2 Class A: IEC61000-4-2 (ESD)

		IEC61000-4-3 (RS) IEC61000-4-4 (EFT) IEC61000-4-5 (Surge) IEC61000-4-6 (CS) IEC61000-4-8 (Magnetic Field)
	Free Fall	IEC60068-2-32
	Shock	IEC60068-2-27
	Vibration	IEC60068-2-6
	Green	RoHS Compliant
	Safety	FCC, CE
	Warranty	5 Years

Table 6.1
Technical Specifications

Antaira Customer Service and Support

(Antaira US Headquarter) + 844-268-2472

(Antaira Europe Office) + 48-22-862-88-81

(Antaira Asia Office) + 886-2-2218-9733

Please report any problems to Antaira:

www.antaira.com/ / support@antaira.com

www.antaira.eu/ / info@antaira.eu

www.antaira.com.tw/ / info@antaira.com.tw

Any changes to this material will be announced on the Antaira website.